

COMMISSIONING MANUAL

QT/QST553 Water Heater Control Unit
CS20 Chiller Carbonator

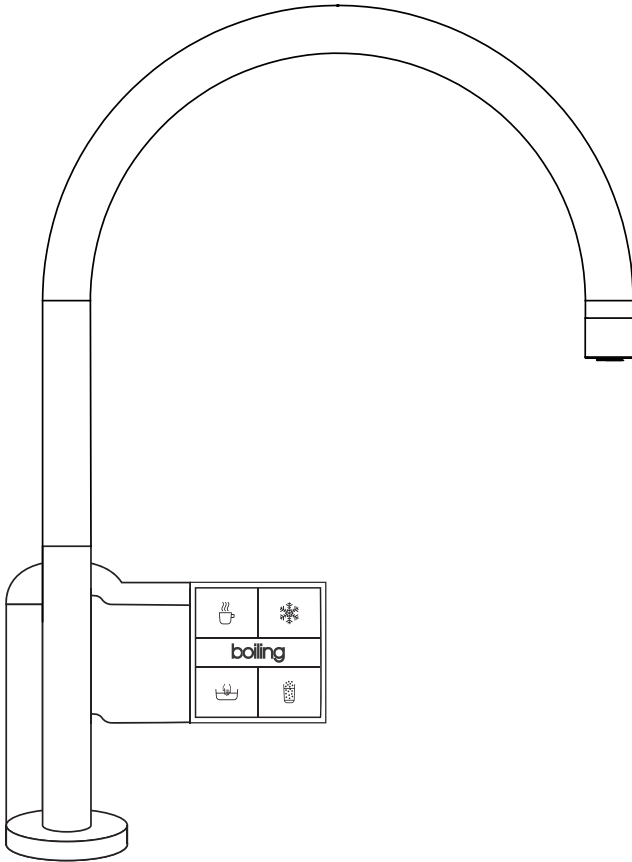

BOILING



CHILLED



SPARKLING



HOT & COLD

quatreau[®]
Touch

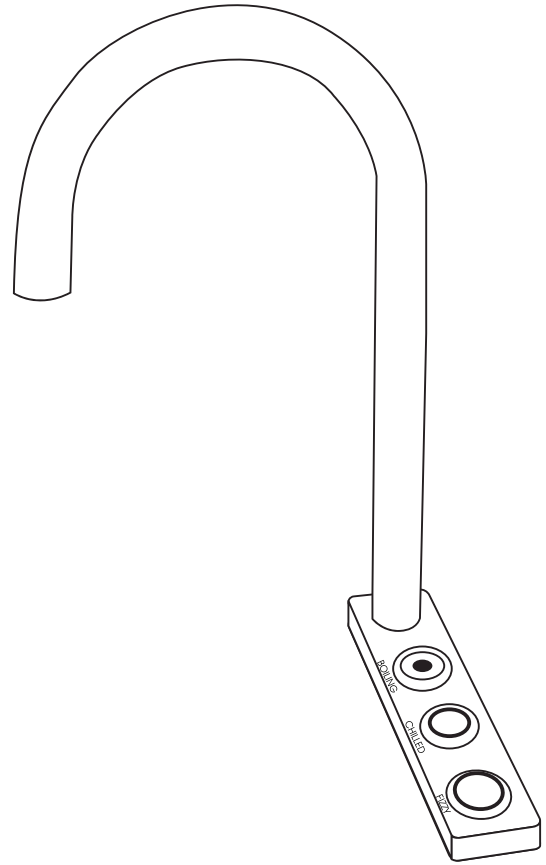

BOILING



CHILLED



SPARKLING

quatreau[®]
SmartTap

110V/60Hz

quatreau[®]
Collection

CONTENTS

QUATREAU COLLECTION COMMISSIONING MANUAL

QT/QST553 Water Heater Control Unit CS20 Chiller Carbonator

- [QUATREAU COLLECTION BEFORE YOU START](#) 1
- [SECTION A: COMMISSIONING SEQUENCE](#) 2
- [SECTION B: WATER HEATER VENTING PROCEDURE](#) 2, 3
- [SECTION C: COMMISSIONING THE CHILLER CARBONATOR](#) 3, 5
- [SECTION C: ADJUSTING CARBONATION IN CHILLER](#) 6
- [SECTION D: CONVERSION TO PURIFIED WATER](#) 6
- [SECTION E: QUATREAU TOUCH TAP
OPTIMUM SETTING FOR MAINS HOT & COLD](#) 6

QUATREAU COLLECTION BEFORE YOU START

Note: Before you start, the following inter-connections must be made between the water heater and the chiller and the returns from the chiller to the water heater unit.

1. The **H2O** (left side of the water heater) is connected to the **WATER IN** on the chiller.

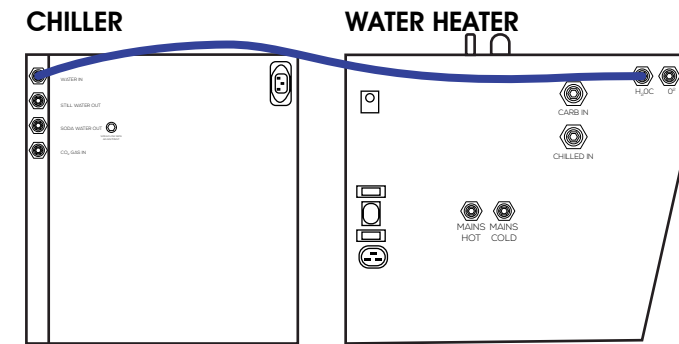

2. The **STILL WATER OUT** on the right of the chiller is connected to the **CHILLED IN** on the left of the water heater.

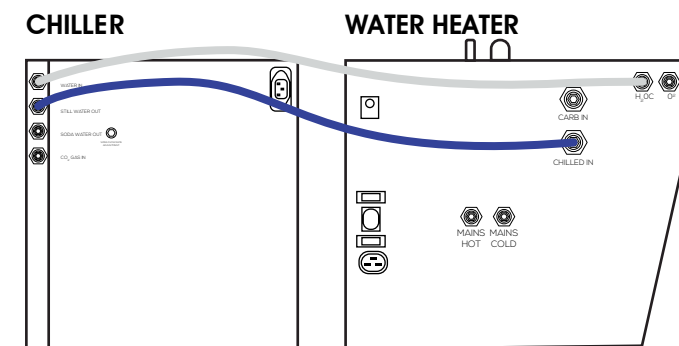

3. The **SODA WATER OUT** on the right of the chiller is connected to the **CARB IN** on the left of the water heater.

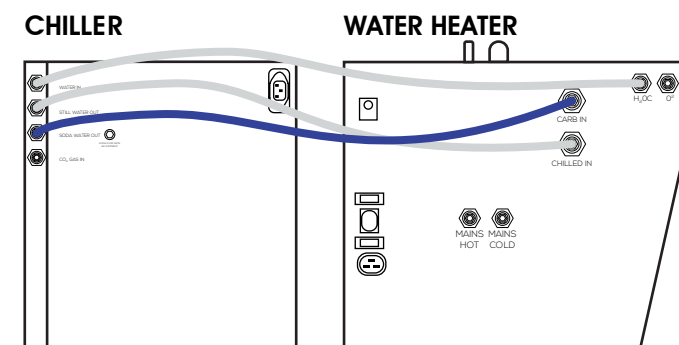

4. For **TouchTap™** models, you will also connect the **COLD WATER SUPPLY** and thermostatically controlled hot to the inlets found on the lower part of the water heater unit at the back left side marked **HOT WATER SUPPLY** and **COLD WATER SUPPLY**.

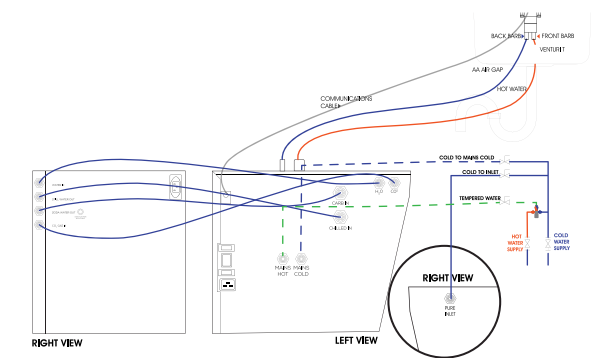

5. **CHLORINATION:** The chiller / chiller carbonator unit must be sanitized 30 minutes before commissioning. This can be done before you start the installation.

To sanitize, run a feed of chlorinated water (approx. 5ppm) through the chiller inlet to the outlet(s). Leave the solution in the chiller and proceed to commissioning.

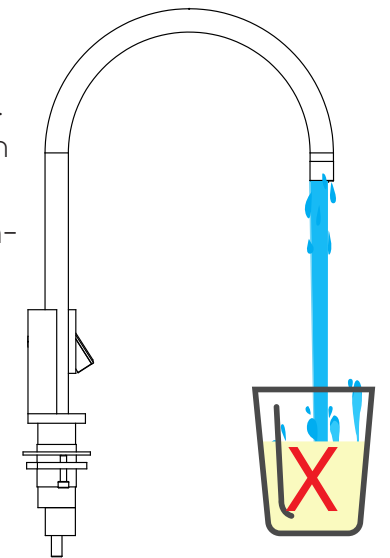

WARNING: DO NOT POWER THE SYSTEM UP UNTIL INSTRUCTED TO DO SO

SECTION A: Commissioning sequence for Quatreau Touch™ and SmartTap™ Boilers (553-B)

1. Connect the communications cable from the tap to the water heater.

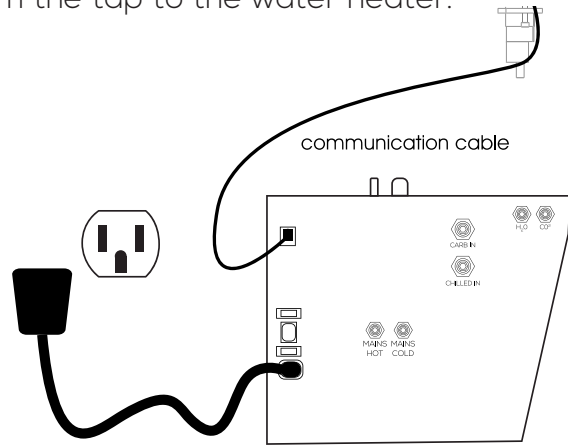

2. Turn on the cold water supply to the 1/4" inlet on the front right side of the water heater.

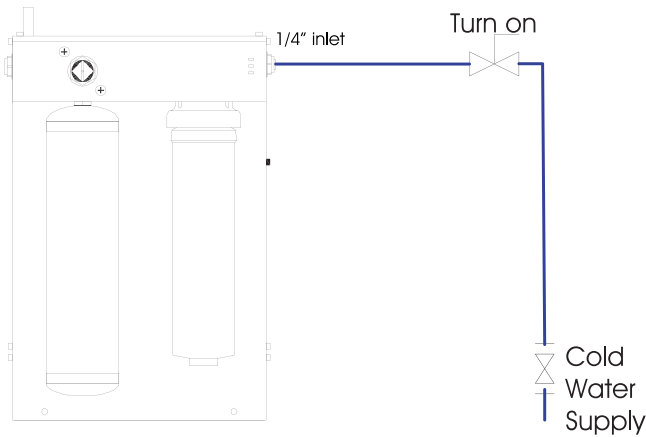

FRONT VIEW

3. Connect the power cable provided for the water heater.
(Note: that this is rated 110 Volts/ 15Amp)

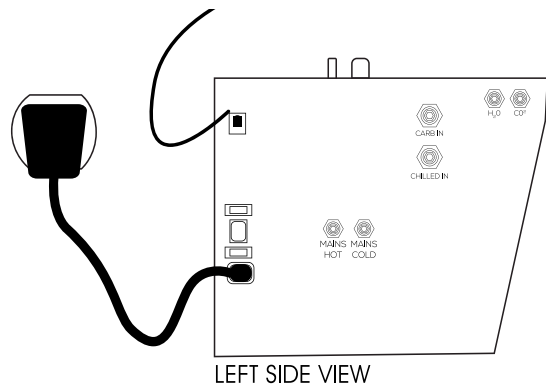

LEFT SIDE VIEW

4. Power up the water heater. A red light will show on the top right of the water heater.

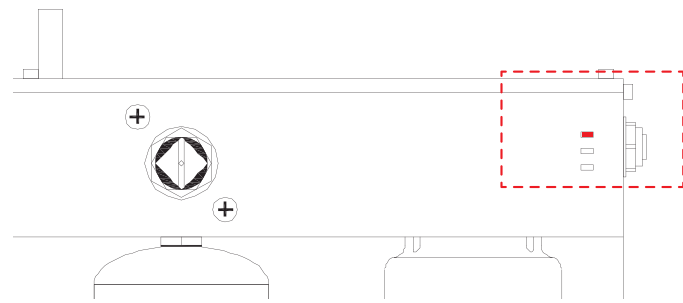

5. Look for the **SmartTap™** buttons on the panel to light up.

6. Look for the **TouchTap™** panel four (4) quadrants to illuminate and then turn off.

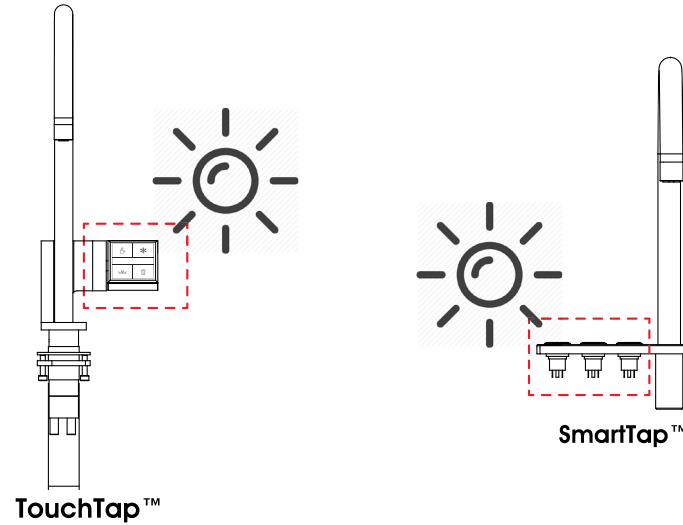

Note: If you do not see the panels light up check the communication cable is connected properly.

SECTION B: Water Heater Venting Procedure

WARNING: To not **damage** the water heater, especially for the first time turning the water heater on, you must run the water through the boiling function five times. (for the touch tap this is the 3 step sequence). When the water heater lights turn green, the system has the correct temperature and ready to use.

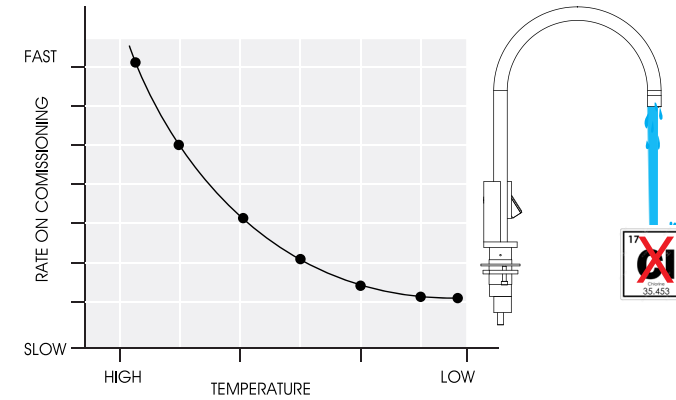

1. Activate the boiling flow at the tap control within 2 minutes of powering up.

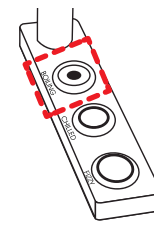

• If you have the SmartTap™ this will be the red illuminated button.

• If you have the TouchTap™, this has a simple three (3) touch sequence - top left quadrant, then the bottom left, then top left again. Please refer to the TouchTap™ installation manual.

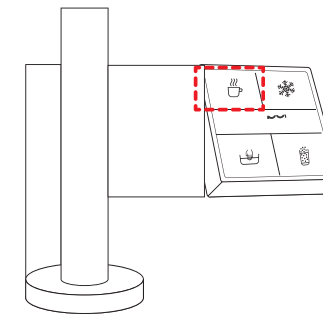

2. Allow water to run for approx. Thirty (30) seconds, then deactivate.

3. Wait for 1 minute and repeat, allowing water to flow for 30 seconds. Repeat this process three (3) times.

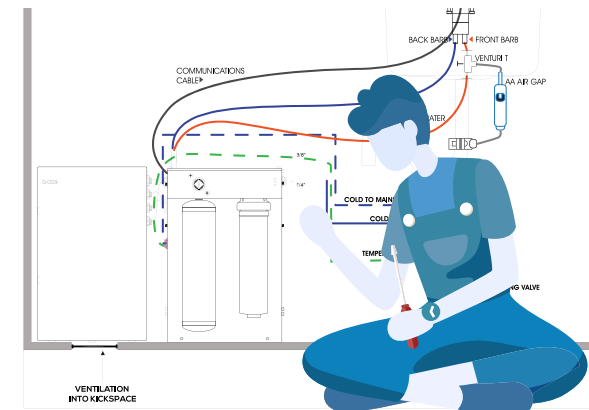

Note: The **SmartTap™** required 6 activations every minute. Repeat every minute for 5 minutes.

4. When the green light on the water heater unit appears and the red light goes out, the water heater has reached its temperature. Your water heater unit is now commissioned and ready for use.

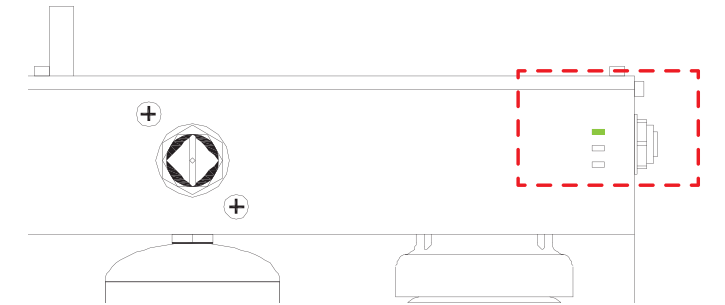

NOTE: that you will see water running through the venturi™ to drain during this process. This unique device enables the water heater to vent safely to drain during expansion and also removes any water left in the spout after use.

SECTION C: Commissioning the Chiller Carbonator CS20

1. **Note:** It is essential to understand the inlet solenoid that controls the flow of water into the chiller carbonator from the water heater unit. The inlet solenoid has to be open when we do this commissioning sequence because running the pump dry will lead to failure. **To activate the solenoid, activate the sparkling water.**

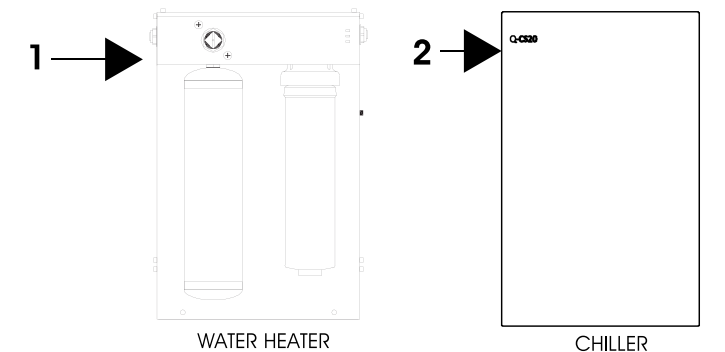

DO NOT TURN ON POWER TO CHILLER UNTIL INSTRUCTED TO DO SO.

2. Turn off the mains cold water feed to the water heater Inlet.

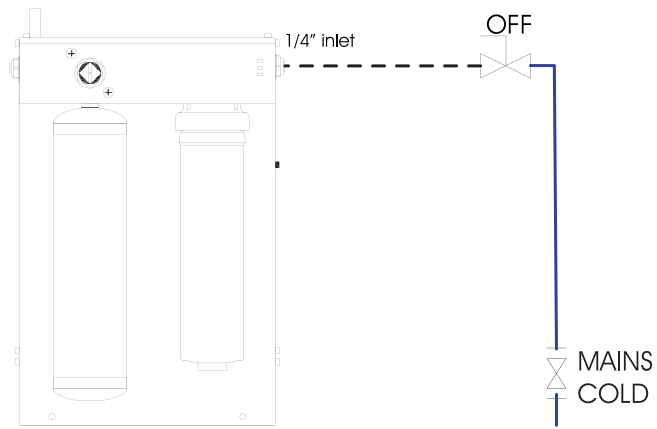

FRONT VIEW

3. Connect the CO2 bottle to the regulator found on the front of the water heater unit. Listen for gas escaping and keep twisting the bottle until it stops. Stop when the bottle is hand tight.



NOTE: If you don't hear the air escaping, there's no gas in the bottle.

4. **DO NOT POWER UP YET.**

- Run the Sparkling option on the tap until gas comes out.
- Deactivate the Sparkling function

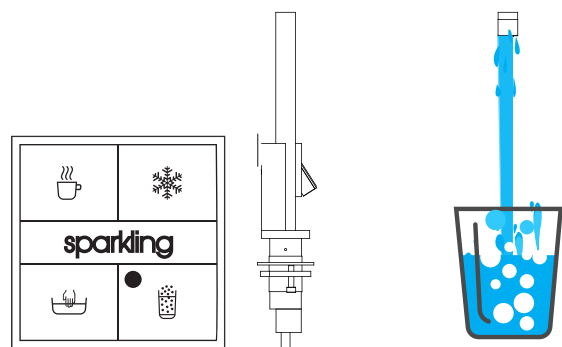

5. Now re-open the mains cold water supply to the water heater Inlet.

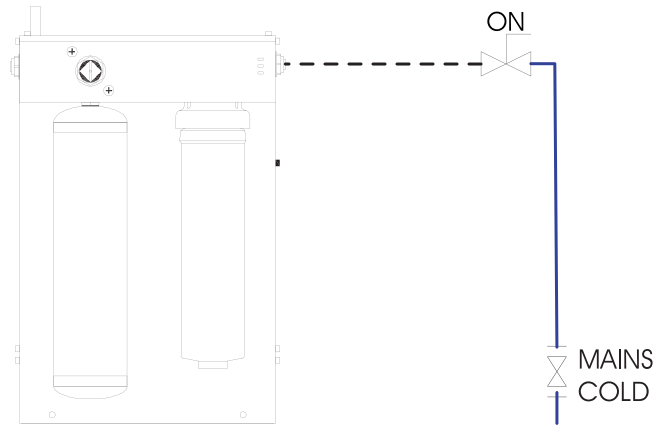

FRONT VIEW

6. Activate the sparkling function on the tap and allow water to run.

7. While the water is running, turn on the chiller carbonator. The pump will turn on, and you will hear it.

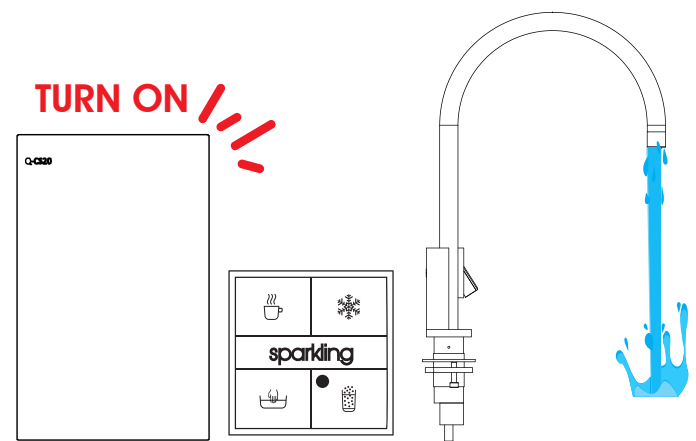

CHILLER

8. Deactivate the Sparkling option.

9. Activate the sparkling option again for a couple of seconds and then deactivate.

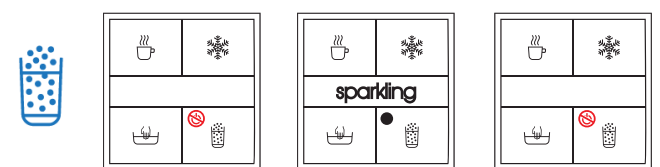

NOTE: Listen for the pump to activate during this process. The pump pressurizes the gas into the water. Activating the sparkling function opens the solenoid that feeds water into the chiller carbonator. When deselecting sparkling, the inlet solenoid remains open for 30 seconds.

so that the pump can continue to feed pressurized water into the chamber where it mixes with the gas. The pump will be damaged if it is starved of water (this is why the solenoid has a delay).

If you hear the pump running beyond 20 seconds simply activate the sparkling for 1-2 seconds to open the solenoid. **DO NOT ALLOW SYSTEM TO RUN DRY.**

10. The compressor and fan in the chiller unit will continue to run until the temperature is reached. This should take approx. 5-10 minutes depending upon the temperature of the incoming mains water supply.

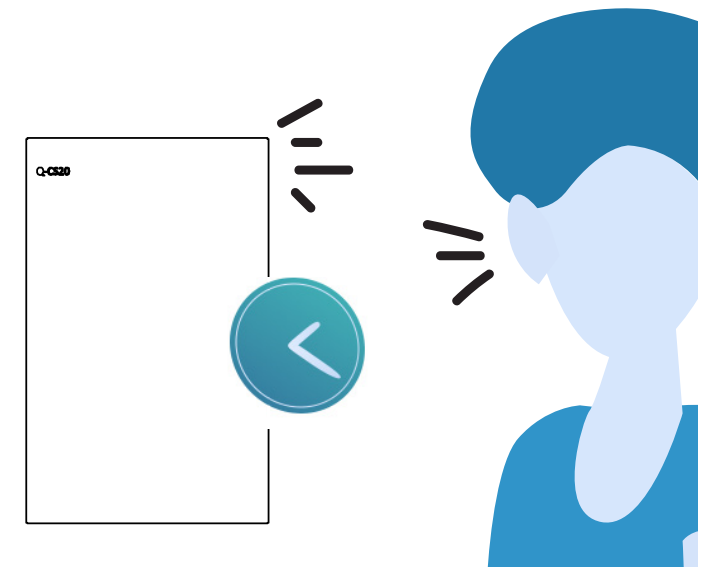

11. When the fan and compressor have stopped, activate the sparkling function again and run off one (1) glassful of water. Deactivate the sparkling and wait for the pump to stop.

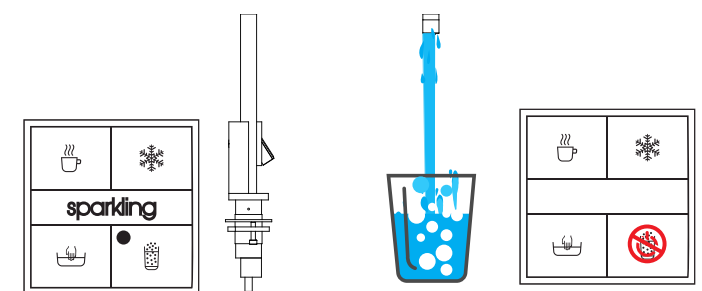

When you turn off the sparkling function the pump should turn off.

Repeat this process for two (2) more glasses of water. (The saturation of CO2 is at its optimum below 4degreesC.)

We are going to wait now for a few minutes until the chiller fan turns off - and the compressor turns off until it drops to 40 degrees Fahrenheit.

12. At this point, let's look at the quality of the water. Activate the sparkling water button. You will hear the pump kick in letting you know the system is working correctly.

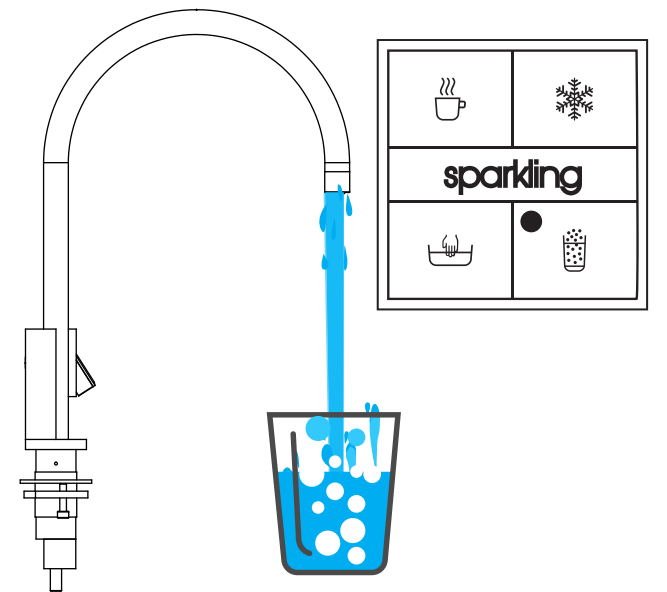

13. See if it is fizzy enough by tasting it. If not, you will be able to adjust using the CO2 regulator.

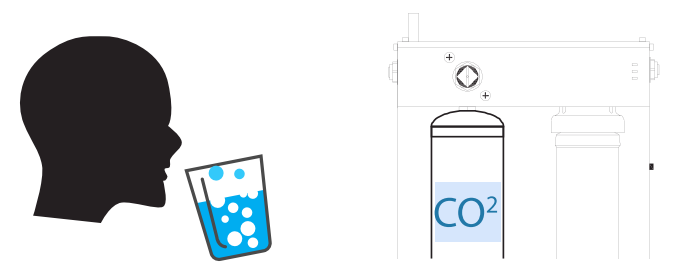

NOTE: Do not go by what the water looks like in the glass you need to taste it.

SECTION C: Adjusting the level of carbonation in the Chiller Carbonator CS20 CS20

14. On the front of the water heater unit, you will find the gas regulator and instructions for increasing the level of carbonation.

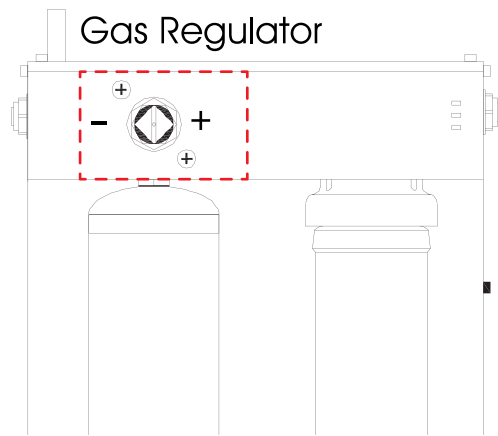

15. When adjusting, make 1/4 turn adjustments in the desired direction (+/-).
16. After an adjustment, repeat process 11 and 12.

NOTE: If you do not hear the pump activate during this process, power off the chiller and repeat processes 6-9.

SECTION D: Conversion to Purified Water

If you wish to feed your QT/QTS553-BCS from an RO system.

1. First ensure that the storage tank is full.
2. Change the mains feed into the front right side of the water heater to your RO feed.
3. The Optimum operating pressure from the RO system to the water heater and chiller is 3Bar / 45psi.
4. Some RO systems have a maximum pressure of 30 psi from the tank when full. You will therefore need to install a delivery pump set at 3Bar/45 psi to maintain optimum performance.

NOTE: Starvation of water will damage the chiller carbonator pump. Do not run the sparkling function if the RO system has run out of water or pressure drops below 15psi. This invalidates the 12 month warranty.

SECTION E: **QUATREAU TOUCH TAP ONLY** Optimum setting for mains Hot & Cold

Finally, adjust the flow rate of the mains hot and cold down to a point where it doesn't splash when washing hands. The flow should be smooth, calm and have the appearance of a cone at the point where it falls from the faucet.

Distributed by: Global Water Solutions
Find out more at: www.Quatreau.com